



**CHUNG PAK**

---

**SPECIFICATIONS**  
**FOR SILVER OXIDE BUTTON CELL**

**303F**

(Mercury Free)

RECEIVED BY :

Prepared by 

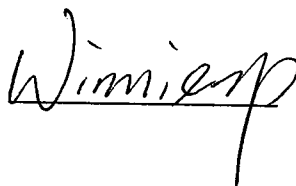
Approved by 

**Date : JUL 2015**

---

CHUNG PAK BATTERY WORKS LIMITED  
7/F CHUNG PAK COMMERCIAL BLDG., 2 CHO YUEN ST., YAU TONG BAY,  
KOWLOON, HONG KONG  
TEL: (852) 27171338 FAX: (852) 2772727  
WEBSITE: [www.chungpak.com](http://www.chungpak.com) E-MAIL ADDRESS: [cpgsales@chungpak.com](mailto:cpgsales@chungpak.com)

CHUNG PAK (GUANG DONG) BATTERY INDUSTRIAL CO., LTD  
ADDRESS: GAN CHUN FU CHEN ROAD, CHEN CHUN TOWN, SHUN DE SECTION,  
FO SHAN CITY, GUANG DONG.  
TEL: (0757) 233123338 FAX: (0757) 23312339  
E-MAIL: [sdcpbs@pub.sdnet.gd.cn](mailto:sdcpbs@pub.sdnet.gd.cn) WEBSITE: [www.chungpak.com](http://www.chungpak.com)

---

We reserve all rights for the change of product specification and any information without any prior notice.



## Silver Oxide Button Cell 303F

### 1 · Scope

The specification is applicable to the “Vinnic” brand Silver Oxide Button Cell 303F (Mercury free) supplied by CHUNG PAK BATTERY WORKS LTD.

### 2 · Kind of Products Specified

Name (Designation) : 303F

IEC Designation : SR44

### 3 · Technical Specification

3.1 Dimension :

Height (H)	5.4	<sup>+0</sup> <sub>-0.4</sub>	mm
Diameter (Φ)	11.6	<sup>+0</sup> <sub>-0.25</sub>	mm

3.2 Average Weight : 1.94 g

3.3 Nominal Voltage : 1.55 V

3.4 Nominal Capacity : 133 mAh (Discharge at 1KΩ to 0.9V )

3.5 Typical Discharge Duration: 100 hrs (Discharge at 1KΩ to 0.9V )

540 hrs (Discharge at 6.8KΩ to 1.2V )

3.6 The Drawing of the Finished Battery :

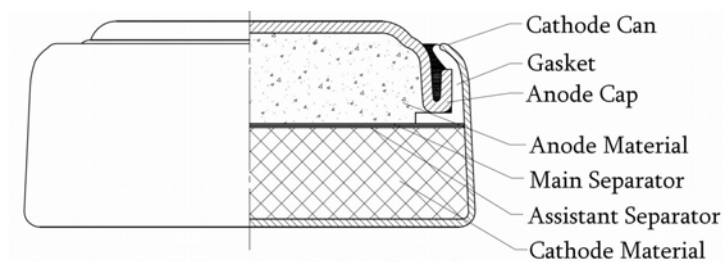



## Silver Oxide Button Cell 303F

### 3.7 Outside Shape Dimensions and Terminals :

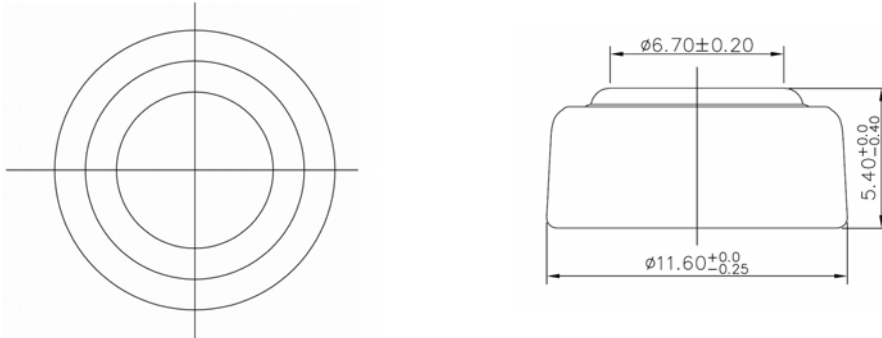

## 4 · Performance

### 4.1 Open-circuit Voltage :

Initial	1.55 – 1.63 V
After 12 Months Storage	1.55 – 1.63 V

### 4.2 Service Out-put :

Load Resistance	1K $\Omega$	6.8K $\Omega$
Discharge Method	Continuously	Continuously
End-point Voltage	0.9V	1.2V
Minimum Duration (Initial)	95 Hrs	486 Hrs
Minimum Duration (After 12 Months Storage)	86 Hrs	440 Hrs

Remark : The word “initial” is applicable to the products elapsed three months or less after production. Satisfaction Standard:

### 4.3 High Temperature Electrolyte Leakage Resistance :

No deformation and no external electrolyte leakage shall be observed.

### 4.4 Expiry period : One year .



## Silver Oxide Button Cell 303F

### 5 · Brand and packaging

5.1 Appendix 1: Standard and Packaging

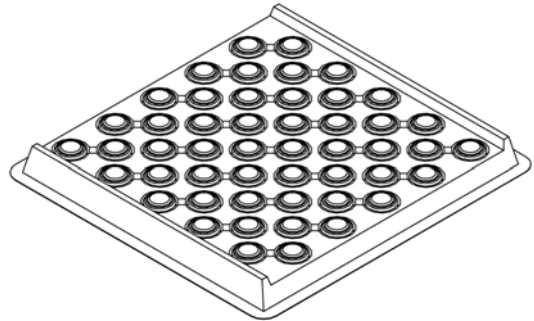

Silver oxide Button Cell 303F

50PCS Per Display Pallet

White Insulating Pallet Measure : 130X123.5X11 mm

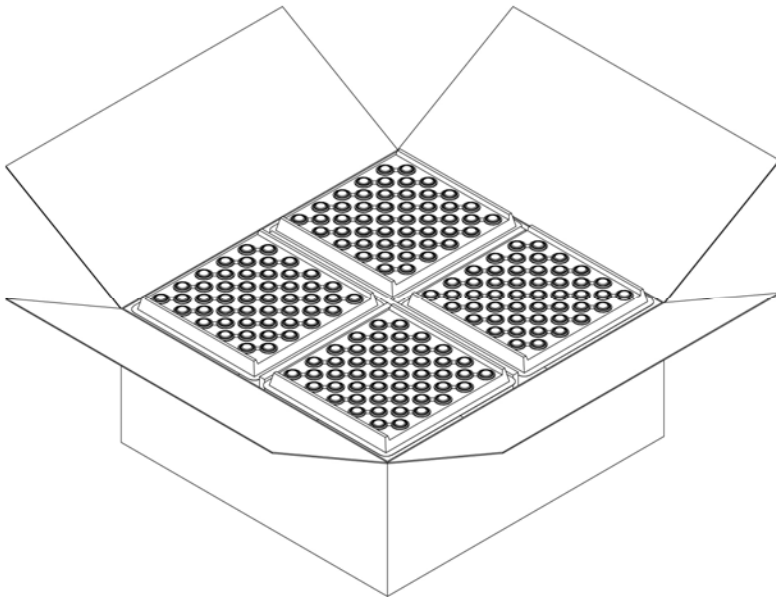

4000 PCS Per Display Carton

Carton Measure : 270X260X129 mm

5.2 Any specific design and packing requirements will be accommodated as required.

## Silver Oxide Button Cell 303F

### 6 · Safety instructions

Warning	Danger
① Don't throw the batteries into fire or heat the batteries.	This may cause the batteries to disrupt or ignite.
② Don't directly solder the batteries.	This may damage their insulating tapes and protective installation.
③ Don't insert and use batteries with the  &  electrode inverse.	This can damage the batteries for being force charged, even may cause leakage, heat generation , disrupt, explosion or ignition.
④ Don't short-circuit the positive and negative terminals of a battery.	This may cause heat generation, leakage, explosion, fire and personal injury.
⑤ Don't expose the batteries to water.	This can cause heat generation or rust.
⑥ Don't charge and force discharge batteries.	This may cause leakage, heat generation, even explosion and ignition.
⑦ Don't disassemble or damage the external tubes of the batteries or modify the batteries(stack-up batteries) etc.	This easily results in short-circuit, leakage, even ignition.
⑧ Store unused batteries in their original packaging away from metal objects.	This can cause battery short-circuiting which may result in venting, leakage, and explosion and personal injury.
⑨ Don't crush, puncture, or otherwise mutilate to deform batteries.	This may cause venting, leakage, explosion and personal injury.
⑩ Immediately stop using the batteries if leakage, discolor or etc. with them are detected.	This may cause accidents to occur.
⑪ Don't drop or strongly strike the batteries.	This may result in leakage, heat generation, disrupt, even ignition.
⑫ To avoid using at high temperature and high humidity ambient.	This may cause batteries early damage.
⑬ a. Be sure to use the batteries within a temperature range from 0°C to 40°C.  b. Be sure to storage the batteries within a temperature range at 20±5°C.	a. Use the batteries beyond the temperature range may cause leakage, heat generation, impaired performance, and shortening of service life of the batteries.  b. Storage the batteries beyond the temperature range may cause heat generation, impaired performance, and shortening of service life of the batteries.
⑭ Don't use old batteries with new ones.	Some batteries may be over-discharged. This can result in venting, leakage, explosion and personal injury.
⑮ Don't use our batteries with any other type or brand of batteries.	Mixed-matching of batteries may result in heat generation, leakage or explosion.
⑯ Remove batteries from equipment if it is not to be used for an extended period of time.	When batteries beyond expiry period, electrolyte leakage may occur causing damage to the equipment.
⑰ Exhausted batteries should be immediately removed from equipment.	When discharged batteries are kept in the equipment for a long time, electrolyte leakage may occur causing damage to the appliance and/or personal injury.
⑱ Keep the batteries out of the reach of children.	To avoid being swallowed. If swallowed, Please see doctor immediately.
⑲ Don't allow children to replace batteries without adult supervision.	This may cause wrong operation, even may occur accident.
⑳ Please use batteries within expiry period.	When batteries beyond expiry period, electrolyte leakage may occur causing damage to the equipment. And may impair batteries performance.
㉑ Don't take batteries by hand directly. Please wear finger cots.	This may cause rust.
㉒ Don't take batteries with iron tweezer. Please use plastic tweezer.	This can cause battery short-circuiting which may result in heat generation , leakage, and explosion.



## Silver Oxide Button Cell 303F

### *Appendix 1 : Test*

#### **1. Storage and Test Conditions for Samples**

Unless otherwise specified, the storage conditions for samples shall be, as a general rule, at the temperature of  $20\pm 2^{\circ}\text{C}$  and the humidity of  $65\pm 20\%$ .

#### **2. Measuring Instruments**

2.1 Voltmeter : The accuracy of the voltmeter shall be within 0.005V for each 1.5V. The resistance of the measuring instrument shall be at least 10 times the discharge resistance but with a minimum of 1 M ohms per volt of the scale.

2.2 Load Resistance : The load resistance shall include all of the external circuit, and its allowance shall be within  $\pm 0.5\%$ .

2.3 Caliper : The caliper shall be the one having precision of 0.02 millimeters or the one having the same or superior precision to this.

#### **3. Test Method**

3.1 Dimensions : Measurements shall be made by use of the calipers.

3.2 Appearance : Examination shall be carried out by visual inspection .

3.3 Open-circuit Voltage : Measurements shall be carried out before the start of discharge of the sample by use of the voltmeter .

3.4 Service Out-put :

Discharge Start Time : After leaving in an atmosphere at a temperature of  $20\pm 2^{\circ}\text{C}$  for at least 8 hours or more .

Discharge Method : As defined in 4.2 , page 2 .

Discharge End-point : The instant when the closed-circuit voltage has reached below the end-point voltage(as defined in 4.2, page 2).

3.5 High Temperature Electrolyte Leakage Resistance

The following conditions shall be adopted for the test :

- (1) Test temperature and humidity :  $45\pm 2^{\circ}\text{C}$ , below 70%RH .
- (2) Test period : Leave to stand still 30 days .



## Silver Oxide Button Cell 303F

### Appendix 2 : Discharge Characteristics

Standard Discharge Curve :

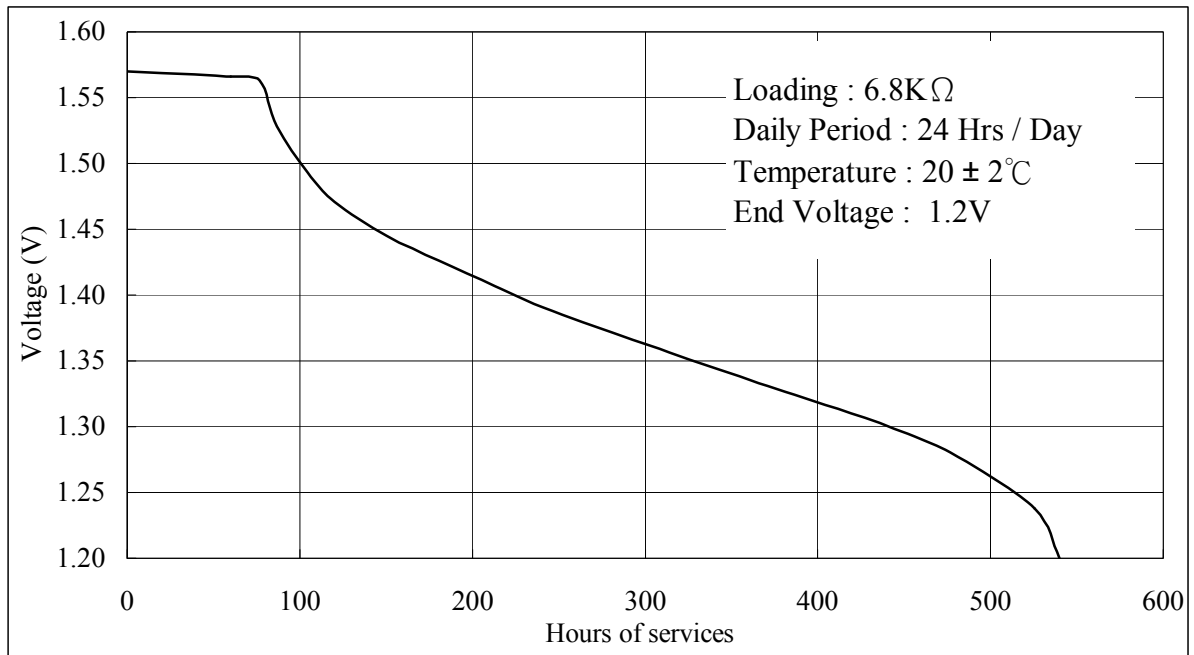
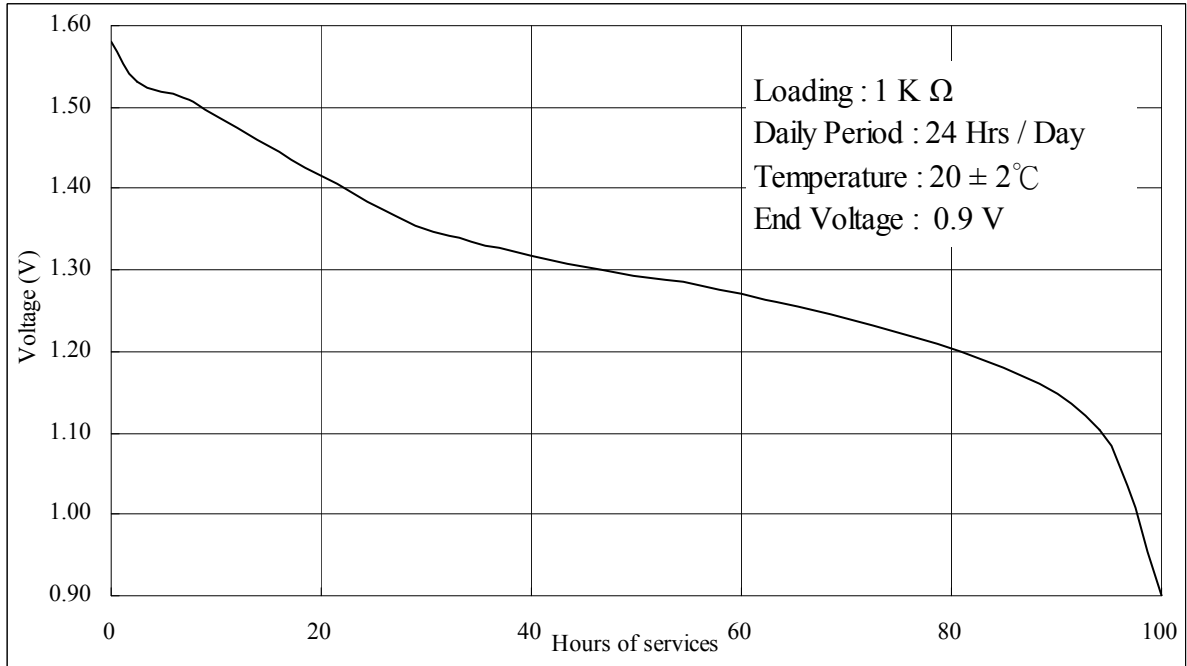



### Silver Oxide Button Cell 303F

Temperature Characteristic :

